

Godox

AD300^{Pro}

外拍灯 | Outdoor Flash



深圳市神牛摄影器材有限公司
GODOX Photo Equipment Co., Ltd.

地址/Add: 深圳市宝安区福海街道塘尾社区耀川工业区厂房2栋
Building 2, Yaochuan Industrial Zone, Tangwei Community, Fuhai Street, Bao'an District, Shenzhen, China
电话/Tel: +86-755-29609320(8062) 传真/Fax: +86-755-25723423
邮箱/E-mail: godox@godox.com http://www.godox.com
705-AD30P0-00 Made In China



使用手册

INSTRUCTION MANUAL

Foreword

Before using this product

Please read this user manual carefully in order to ensure your safety and the proper operation of this product. Keep for future reference.

Thank you for purchasing a GODOX product.

AD300Pro Outdoor Flash has strong power with light weight, compact size and great portability. Equipped with rechargeable and long-life lithium battery, AD300Pro supports various of accessories by replacing different adapter rings.

Built-in Godox 2.4G wireless X system and fully support of TTL function, your shooting process will become more smooth using AD300Pro. Easily achieve a correct flash exposure even in complex light-changing environment.

The AD300Pro offers:

- **Compatible wireless TTL system:** Fully support TTL/M/Multi functions of Canon, Nikon, Sony, Fuji, Olympus, Panasonic and Pentax cameras. Workable as Slave unit in a wireless flash group.
- **Lightweight and portable:** up to 300Ws.
- **High-quality VA panel:** with clear and convenient operation.
- **Built-in 2.4G wireless transmission:** with all-in-one functions and 100 meters further transmission.
- **Battery pack:** Large-capacity power supply (lithium, 14.4V/2600mAh), 0.01- 1.5s recycling and over 320 full power flashes.
- **Wireless control:** With built-in Godox 2.4G wireless X system to achieve TTL control. Godox FT-16 flash trigger can also be used to wirelessly adjust flash power level and trigger the flash. AD300Pro has 3.5mm sync cord jack to achieve various sync triggering mode.
- **Power adjusts from full power to 1/256 in 81 levels.**
- **Change within $\pm 100K$ over the entire power range in color temperature mode.**
- **1/8000s high-speed sync flash, high-speed sync triggering.**

The powerful and portable AD300Pro meets the demands of freelance commercial photographers, photojournalists, wedding and beach portraiture shooters, event and backpack photographers, photograph enthusiasts, etc.

Warning

- ⚠ Always keep this product dry. Do not use in rain or in damp conditions.
- ⚠ Do not disassemble. Should repairs become necessary, this product must be sent to an authorized maintenance center.
- ⚠ Keep out of reach of children.
- ⚠ Stop using this product if it breaks open due to extrusion, falling or strong hit. Otherwise, electric shock may occur if you touch the electronic parts inside it.
- ⚠ Do not fire the flash directly into the eyes (especially those of babies) within short distances. Otherwise visual impairment may occur.
- ⚠ Do not use the flash unit in the presence of flammable gases, chemicals and other similar materials. In certain circumstance, these materials may be sensitive to the strong light emitting from this flash unit and fire or electromagnetic interference may result.
- ⚠ Do not leave or store the flash unit if the ambient temperature reads over 50°C. Otherwise the electronic parts may be damaged.
- ⚠ Turn off the flash unit immediately in the event of malfunction.
- ⚠ The light source of this luminaire is not replaceable; when the light source reaches its end of life the whole luminaire shall be replaced.
- ⚠ Minimum distances from flammable materials: 10cm.

Contents

21	Foreword
22	Warning
25	Name of Parts
	Body
	VA Panel
	Included Accessories
	Separately Sold Accessories
	Replacing Adapter Rings and Accessories
	Attaching and Detaching Flash Tube
30	Battery
30	Power Management
31	Modeling Lamp
31	Wireless Flash Mode
31	Flash Mode—TTL Autoflash
31	TTL Mode
	 High-Speed Sync
32	Flash Mode—M: Manual Flash
34	Flash Mode—Multi/Stroboscopic Flash
35	Wireless Flash Shooting: Radio (2.4G) Transmission
37	C.Fn: Setting Custom Functions
38	Other Applications
	Zooming Function
	Sync Triggering
39	Protection Function
40	Technical Data
41	Firmware Upgrade
41	Maintenance

Conventions used in this Manual

- This manual is based on the assumption that both the camera and camera flash's power switches are powered on.
- Reference page numbers are indicated by "p.**".
- The following alert symbols are used in this manual:
 - ▲ The Caution symbol indicates a warning to prevent shooting problem.
 - The Note symbol gives supplemental information.

Name of Parts

Body:

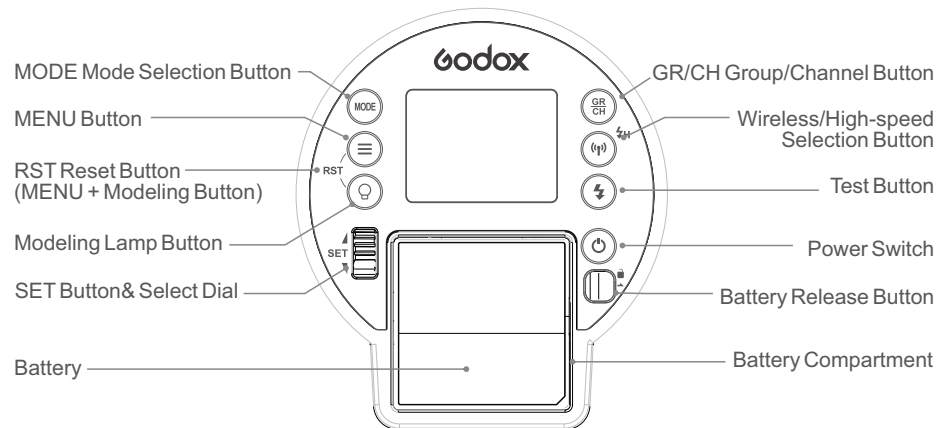
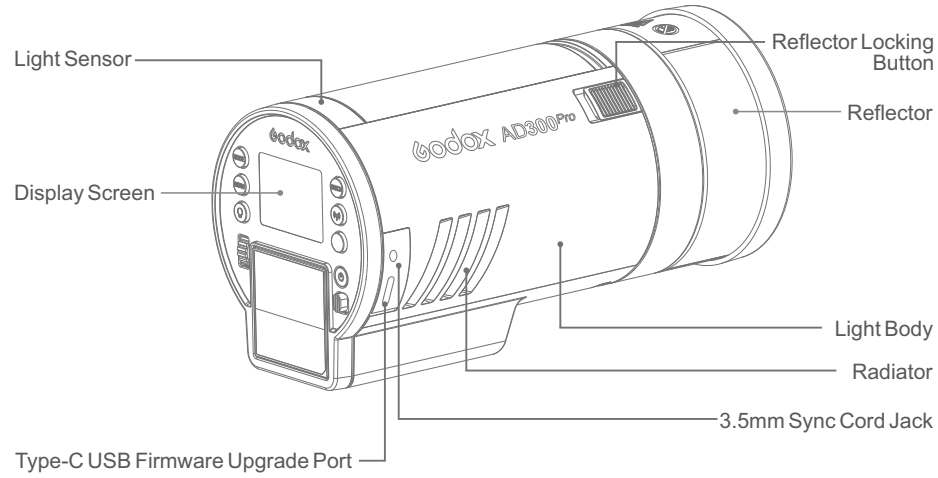

Name of Parts

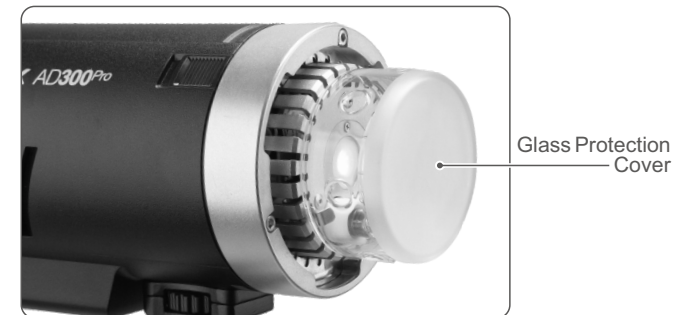
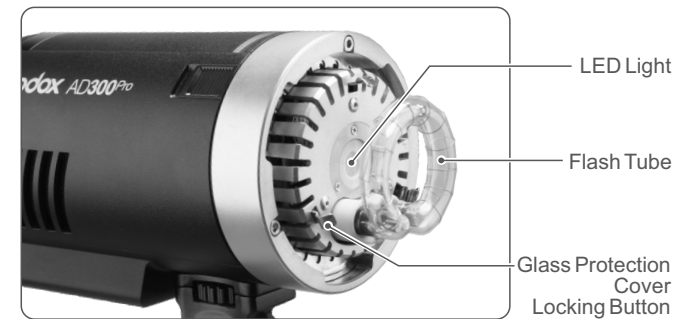
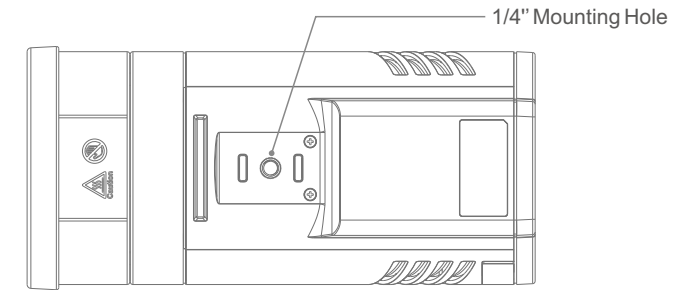

Name of Parts

VA Panel

(1) VA Panel

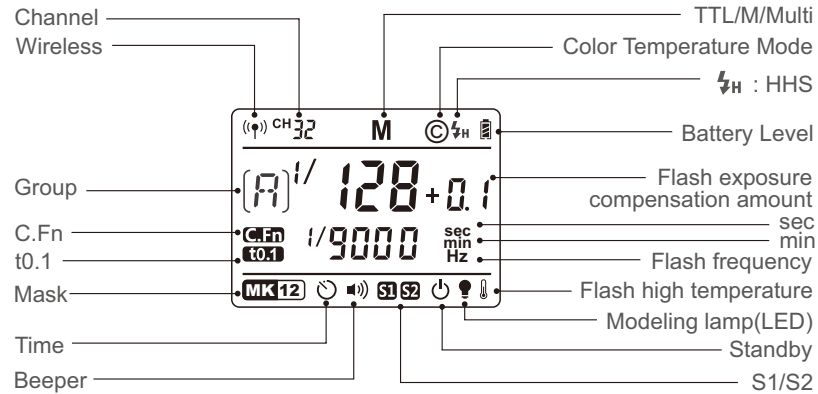

- The display will only show the settings currently applied.
- The functions displayed above function buttons 1 to 4, such as **SYNC** and **⚡**, change according to settings' status.
- When a button or dial is operated, the VA panel illuminated.

(2) M Manual Flash

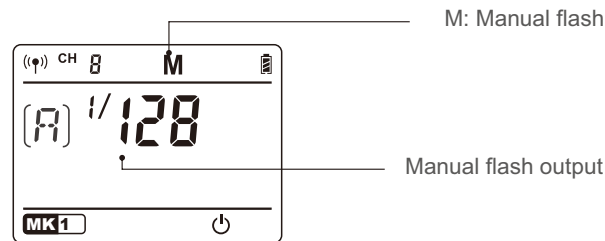

(3) Multi Flash

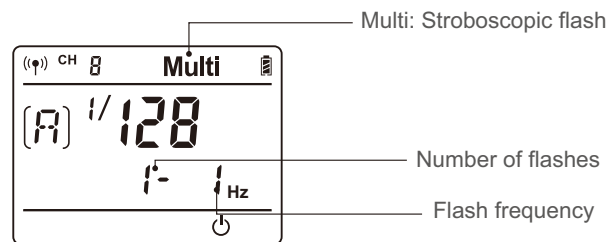

Name of Parts

(4) Radio Transmission Shooting

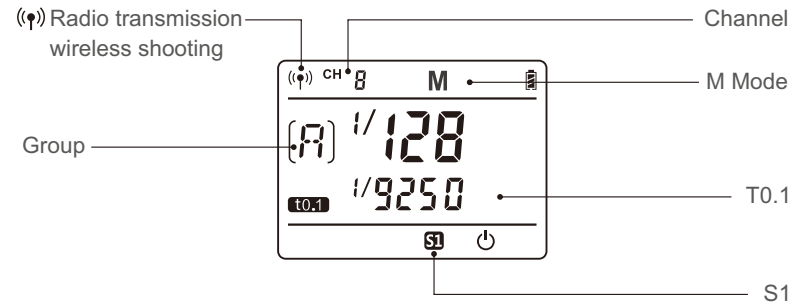

- S1/S2

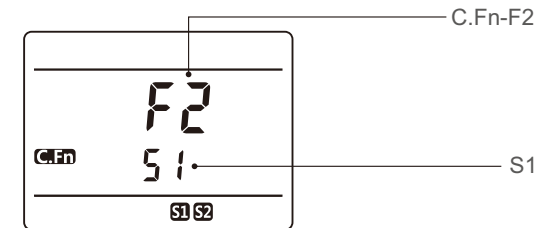

Included Accessories

1. Light body
2. Flash tube
3. Glass protection cover
4. Reflector
5. AD-E2 bracket
6. Battery
7. Charger
8. Portable bag
9. Instruction manual



Separately Sold Accessories

The product can be used in combination with the following accessories sold separately, so as to achieve best photography effects: XPro, X2 and X1 Wireless Flash Trigger, Adapter Ring Holder, Bowens/Elinchrom/Comet mount adapter ring, Barn Adapter Rings, Softbox, Beauty Dish, Fold up umbrella, Snoots, Light stand, etc.



Name of Parts

Replacing Adapter Rings and Accessories



1 Remove the reflector or other accessories from the flash head.



2 Install the first half of adapter holder into the fixing slot. Then, install another half to form a circle.



3 Match the Bowens mount or other adapter ring to the adapter holder.



4 Tighten the four screws.



5 Install the accessories of different mounts. If needed to use new Godox-mount accessories after installing the adapter ring of other brand, just install them directly.

Attaching Flash Tube

Install Flash Tube



1 Remove the reflector or other accessories from the flash head.



2 Match the flash tube in the Tube Socket. Push the flash tube in until it is securely seated into the socket.



3 Firstly, lock tightly spring 1 and press down the spring 2 and 3 simultaneously. Then, install the glass protection cover.

Detach Flash Tube



1 Pull out the glass protection cover from the spring 2 and 3 before 1.



2 Pinch the flash tube holder with your thumb and forefinger and pull out the tube upwards.

Lithium Battery

Features

1. This flash unit uses Li-ion polymer battery which has long runtime. The Available charge-and-discharge times are 500.
2. It is reliably safe. The inner circuit is against overcharge, overdischarge, overcurrent, and short circuit.
3. Take only 2.5 hours to fully charge the battery by using the standard battery charger.

Cautions:

- Do not short circuit.
- Do not expose to rain or immerse into water. This battery is not water proof.
- Keep out of reach of children.
- No over 24 hours' continuous charging.
- Store in dry, cool, ventilated places.
- Do not put aside or into fire.
- Dead batteries should be disposed according to local regulations.
- Long time not to use, please charge it to 60% and then placed.
- It is recommended to fully recharge the battery every three months.

Battery Level Indication

Make sure the battery pack is securely loaded in the flash. Check the battery level indication on the VA panel to see the remaining battery level.

Battery Level Indication on the VA Panel	Meaning
3 grids	Full battery
2 grids	Medium battery
1 grid	Low battery
Blank grid	Lower battery, please recharge it.
Blinking	The battery level is going to be used out immediately. And the flash will auto power off in 1 minute. Note: Please recharge the battery as soon as possible (within 10 days). Then, the battery can be used or be placed for long period.

Power Management

ON/OFF Power Switch controls the on/off of the flash unit, turn off the power pack if the flash unit will not be used for an extended period. The product design of power supply with automatic hibernation feature, When unattended operation for a long time (approx. 30/60/90 minutes), the flash will automatically standby.

 **C.Fn** Disabling Auto Power standby function is recommended when the flash is used off camera. (C.Fn-F3, Page 39)

Modeling Lamp

1. **Power on/off the modeling lamp:** short press the <Q> to control the modeling lamp's on or off.

2. **Setting:** long press the <Q> to enter modeling lamp setting.

2.1 Brightness setting: press the SET button and the brightness value is blinking. Turn the select dial to change the brightness value from 1 to 10 level.

2.2 Color temperature setting: press the SET button and the color temperature value is blinking. Turn the select dial to change the color temperature value from 3000K to 6000K(±500K).

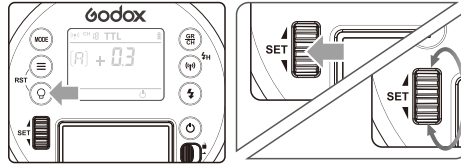

High-Speed Sync

High Speed Sync (FP flash) enables the flash to synchronize with all camera shutter speeds. This is convenient when you want to use aperture priority for fill-flash portraits.

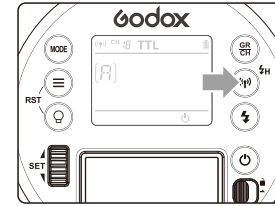

1 Long Press Wireless Button <Q> for 2 seconds so that <H> is displayed.

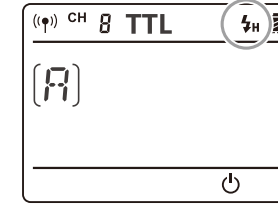

2 Please use the X2 series transmitter to trigger.

- With high-speed sync, the faster the shutter speed, the shorter the effective flash range.
- Multi flash mode cannot be set in high-speed sync mode.
- Over-temperature protection may be activated after 20 consecutive high-speed sync flashes.

Wireless Flash Mode

AD300Pro can only be set as slave unit (receiver end). Short press the wireless selection button to switch the radio transmission function.

Wireless Mode	Flash Mode
OFF	M / Multi
Radio Transmission	TTL / M / Multi

Flash Mode — TTL Autoflash

This flash has three flash modes: TTL, Manual (M), and Multi (Stroboscopic). In TTL mode, the camera and the flash will work together to calculate the correct exposure for the subject and the background. In this mode, multiple TTL functions are Available: FEC, FEB, FEL, HSS, second curtain sync, modeling flash, control with the camera's menu screen.

* Press <MODE> Mode Selection Button and three flash modes will display on the VA panel one by one with each pressing.

TTL Mode

Press <MODE> Mode Selection Button to enter TTL mode. The VA panel is displayed <TTL>.

Flash Mode — M: Manual Flash

The flash output is adjustable from 1/1 full power to 1/256th power in 1/10th step or 1 step increments. To obtain a correct flash exposure, use a hand-held flash meter to determine the required flash output.

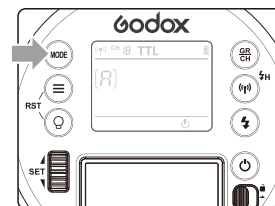

1 Press <MODE> button so that <M> is displayed.

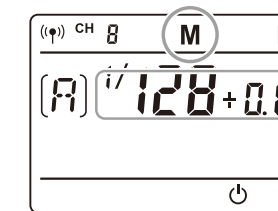

2 Turn the Select Dial or press the SET button and turn the Select Dial simultaneously to set the flash output. The flash output will be adjustable from 1/10th increment or 1 step increment by turning the Select Dial directly or pressing the SET button and turn the Select Dial simultaneously.

Optic S1 Secondary Unit Setting

In M manual flash mode, press the <MENU> button to enter C.FN-F2 to choose S1 function, so that this flash can function as an optic S1 secondary flash with optic sensor. With this function, the flash will fire synchronously when the main flash fires, the same effect as that by the use of radio triggers. This helps create multiple lighting effects.

Optic S2 Secondary Unit Setting

Press the <MENU> button to enter C.FN-F2 to choose S2 function, so that this flash can also function as an optic S2 secondary flash with optic sensor in M manual flash mode. This is useful when cameras have pre-flash function. With this function, the flash will ignore a single “pre-flash” from the main flash and will only fire in response to the second, actual flash from the main unit.

• S1 and S2 optic triggering is only available in M manual flash mode.

Display Flash Duration

Flash duration refers to the length of time that from flash's firing to reach the half peak at maximum. The half peak at maximum is usually expressed as $t=0.5$. In order to provide the photographer with more concrete data, this product adopts $t=0.1$. The difference between $t=0.5$ and $t=0.1$ is shown in the following picture.

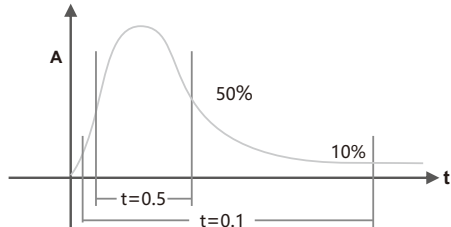

Display Flash Duration Operation:

1. Press the <MENU> button to enter C.FN function.
2. Adjust the Select Dial to F6, the $t=0.1$ icon will be displayed on the VA panel.
3. Press <SET> button to enter the adjustment condition.
4. Turn the Select Dial to choose the ON/OFF.

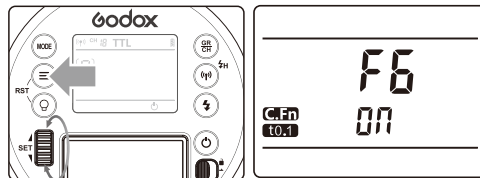

• The flash duration will only be displayed on the VA panel in M mode.

Stable Color Temperature Function

When use this function, the color temperature changes within $\pm 100K$ over the entire power range: enter MENU C.Fn-08 and set it as ON, which means the color temperature function is turned on. When adjusting the power output from high to low in M mode, Flash Ready Indicator will blink (the beeper will alarm for 1 minute). Now press the Test Button to discharge, and the flash can be used as normal.

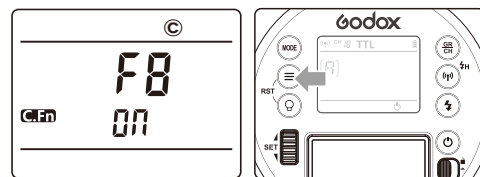

• This function can only be supported in M non-high-speed mode.

Flash Mode — Multi: Stroboscopic Flash

With stroboscopic flash, a rapid series of flashes is fired. It can be used to capture a multiple images of a moving subject in a single photograph. You can set the firing frequency (number of flashes per sec. expressed as Hz), the number of flashes, and the flash output.

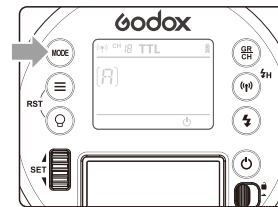

1 Press <MODE> button so that <MULTI> is displayed.

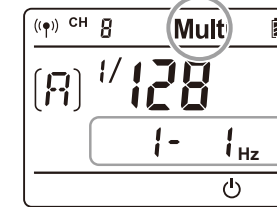

2 Turn the Select Dial to choose a desired flash output.

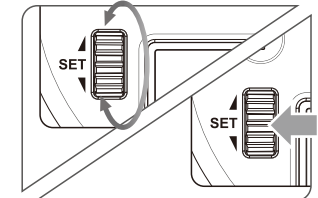

3 Set the flash frequency and flash times.

- Press <SET> button to select the flash frequency. Turn the Select Dial to set the number.
- Press <SET> button to select the flash times. Turn the Select Dial to set the number.
- After finish the setting, press <SET> button and all the settings will be displayed.

Calculating the Shutter Speed

During stroboscopic flash, the shutter remains open until the firing stops. Use the formula below to calculate the shutter speed and set it with the camera.

$$\text{Number of Flashes / Flash Frequency} = \text{Shutter Speed}$$

For example, if the number of flashes is 10 and the firing frequency is 5 Hz, the shutter speed should be at least 2 seconds.

⚠ To Avoid overheating and deteriorating the flash head, do not use stroboscopic flash more than 10 times in succession. After 10 times, allow the camera flash to rest for at least 15 minutes. If you try to use the stroboscopic flash more than 10 times in succession, the firing might stop automatically to protect the flash head. If this happens, allow at least 15 minutes' rest for the camera flash.

- Stroboscopic flash is most effective with a highly reflective subject against a dark background.
- Using a tripod and a remote control is recommended.
- A flash output of 1/1 and 1/2 cannot be set for stroboscopic flash.
- Stroboscopic flash can be used with “buLb”.
- If the number of flashes is displayed as “—”, the firing will continue until the shutter closes or the battery is exhausted. The number of flashes will be limited as shown by the following table.

Maximum Stroboscopic Flashes:

Flash Output \ Hz	1	2	3	4	5	6-7	8-9	10	11	12-14	15-19	20-50	60-99
1/4	7	6	5	4	4	3	3	2	2	2	2	2	2
1/8	14	14	12	10	8	6	5	4	4	4	4	4	4
1/16	30	30	30	20	20	20	10	8	8	8	8	8	8
1/32	60	60	60	50	50	40	30	20	20	20	18	16	12
1/64	90	90	90	80	80	70	60	50	40	40	35	30	20
1/128 1/256	90	90	90	90	90	90	80	70	70	60	50	40	40

Wireless Flash Shooting: Radio (2.4G) Transmission

AD300Pro adopts Godox 2.4G wireless X system, which has good compatibility with other products of our company. As a Slave unit, AD300Pro is automatically compatible with Canon/ Nikon/ Sony TTL system according to the master unit. Nikon cameras (use X1T-N), Canon cameras (use X1T-C) and Sony cameras (use X1T-S) can use one or more AD300Pro-TTL flashes simultaneously.

1. Wireless Settings

Press the wireless selection button to switch wireless function ON/ OFF. Turn the wireless function on, the <((P))> icon will be displayed on the VA panel. When using the FT-16 remote control or others trigger, please turn off the wireless function.

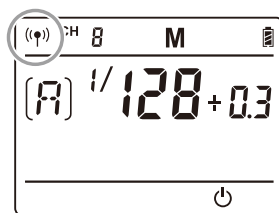
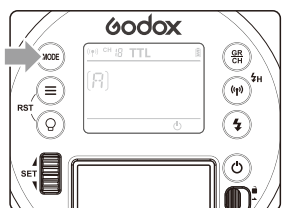

2. Setting the Communication Channel

If there are other wireless flash systems nearby, you can change the channel IDs to prevent signal interference. The channel IDs of the master unit and the Slave unit(s) must be set to the same.

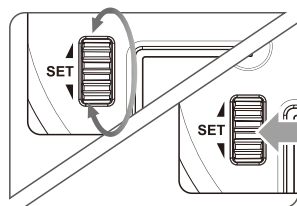
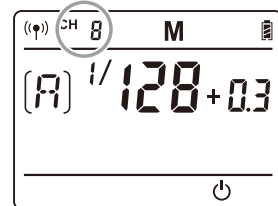
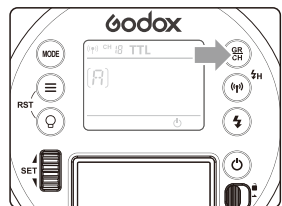

1 Long press the <GR/CH> Button for 2 seconds, so that the icon will be displayed on the VA panel.

2 Turn the Select Dial to choose a channel ID from 1 to 32.

3 Press the <SET> button to confirm.

3. Setting the Communication Group

Short press the < GR/CH > button to choose group ID from A to E.

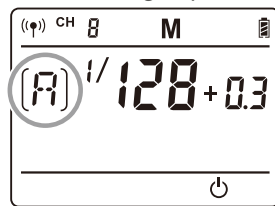
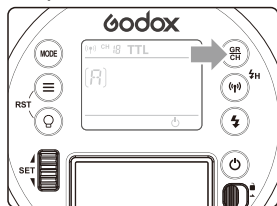

4. Wireless ID Settings

Press the MENU button to enter C.Fn to choose OFF or any figure from 01-99. Note: This can only be used when the master unit possesses the wireless ID function.

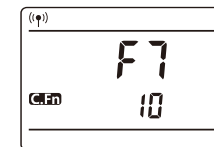

Positioning and Operation Range

(Example of wireless flash shooting)

- Autoflash Shooting with One Slave Unit

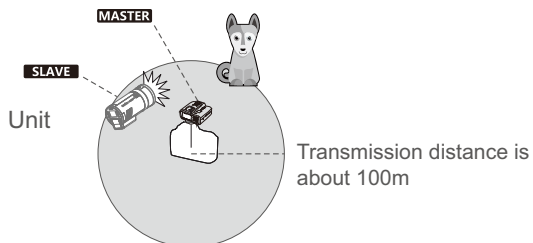

- Use the supplied stand to position the Slave unit.
- Before shooting, perform a test flash and test shooting.
- The transmission distance might be shorter depending on the conditions such as positioning of Slave units, the surrounding environment and whether conditions.
- With a lot of wireless signal interference conditions, if you miss flash, please change the wireless communication channel.

Wireless Multiple Flash Shooting

You can divide the Slave units into two or three groups and perform TTL autoflash while changing the flash ratio (factor). In addition, you can set and shoot with a different flash mode for each firing group, for up to 5 groups.

- Auto Shooting with Two Slave Groups

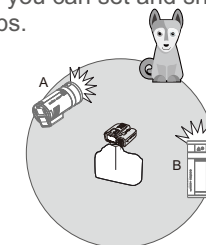

- Auto Shooting with Three Slave Groups

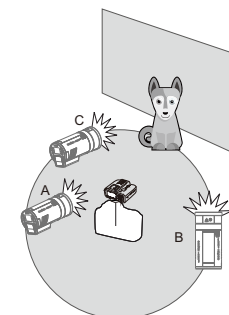

- When using the AD300Pro and Godox X2 series trigger together, the X2 can control the flash function such as:
 - Flash Mode: TTL, M, Multi
 - Sync Mode: First-curtain sync, second-curtain sync and High-speed sync
 - Control the power level
 - Modeling Lamp turn on or off
 - Beeper turn on or off

⚠ The Reason & Solution of Not Triggering in Godox 2.4G Wireless

- 1. Disturbed by the 2.4G signal in outer environment (e.g. wireless base station, 2.4G wifi router, Bluetooth, etc.)**
→ To adjust the channel CH setting on the flash trigger (add 10+ channels) and use the channel which is not disturbed. Or turn off the other 2.4G equipment in working.
- 2. Please make sure that whether the flash has finished its recycle or caught up with the continuous shooting speed or not(the flash ready indicator is lighten) and the flash is not under the state of over-heat protection or other abnormal situation.**
→Please downgrade the flash power output. If the flash is in TTL mode, please try to change it to M mode(a preflash is needed in TTL mode).
- 3. Whether the distance between the flash trigger and the flash is too close or not**
→Please turn on the "close distance wireless mode" on the flash trigger (<0.5m);
X2 & X1 series: press the test button and hold on, then turning it on until the flash ready indicator blinks for 2 times.
XPro series: Set the C.Fn-DIST to 0-30m.
- 4. Whether the flash trigger and the receiver end equipment are in the low battery states or not**
→Please replace the battery(the flash trigger is recommended to use 1.5V disposable alkaline battery).

C.Fn: Setting Custom Functions

The following table lists the Available and unAvailable custom functions of this flash.

Custom Function Signs	Functions	Setting Signs	Settings & Descriptions	Restrictions
F1	Beeper	ON	ON	NO
		OFF	OFF	
F2	S1/S2 mode selection	OFF	OFF	M mode
		S1	S1 mode	
		S2	S2 mode	
F3	Auto standby	OFF	OFF	NO
		30 min	Auto standby without	
		60 min	any operation	
		90 min		
F4	Delay flash	OFF, 0.01~30s	Can be triggered as second curtain	M/Multi mode
F5	Mask	OFF	OFF	M mode
		n1	ON: Trigger 2 times for 1 cycles, 1th flash of trigger.	
		n2	ON: Trigger 2 times for 1 cycles, 2th flash of trigger.	
F6	t0.1 display	ON	Display	M mode
		OFF	Not display	
F7	ID Setting	OFF	OFF	Wireless mode
		01-99	Choose any figure from 01-99	
F8	Stable Color Temperature Mode	OFF	OFF	M non-high-speed mode
		ON	ON	

- 1. Press the <MENU> button to enter the C.Fn meun.**
- 2. Select the custom function No.**
 - Turn the SET Selection Dial to select the custom function No.
- 3. Change the setting**
 - Press < SET > button and the Setting No. blinks.
 - Turn the SET Select Dial to set the desired number. Press < SET > button will confirm the settings.
- 4. Exit C.Fn menu**
 - Press < MENU > button to exit.

Other Applications

Zooming Function

Separately purchase a S2 bracket to achieve zooming function. When installed onto the S2 bracket, AD300Pro can move back and forth to achieve zooming function and gain spotlight or diffused effects.



Sync Triggering

The Sync Cord Jack is a $\Phi 3.5$ mm plug. Insert a trigger plug here and the flash will be fired synchronously with the camera shutter.

Protection Function

1. Over-Temperature Protection

- To Avoid overheating and deteriorating the flash head, the inner over-temperature protection function will be activated. When the over-temperature protection is started,  is shown on the VA display.
- When the recycle time is over 10 seconds in over-temperature protection, please allow a rest time of at least 10 minutes and the flash will then return to normal.

2. Other Protections

- The system provides real-time protection to secure the device and your safety. The following lists prompts for your reference:

Prompts on LCD Panel	Meaning
E1	A failure occurs on the recycling system so that the flash cannot fire. Please restart the flash unit. If the problem still exists, please send this product to a maintenance center.
E2	The system gets excessive heat. Please allow a rest time of 10 minutes.
E3	The voltage on two outlets of the flash tube is too high. Please send this product to a maintenance center.
E9	There are some errors occurred during the upgrading process. Please using the correct firmware upgrade method.

Technical Data

Model	AD300Pro	
Wireless Slave Unit Mode	Radio transmission mode (compatible with Nikon & Canon & Sony & Fujifilm & Olympus & Panasonic & Pentax)	
Flash Mode	Wireless off	M/Multi
	Slave unit of radio transmission	TTL/ M/Multi
Compatible Cameras under Radio Transmission (as Slave unit)	Nikon cameras (X1T-N as master unit)	
	Canon EOS cameras (X1T-C as master unit)	
	Sony cameras (X1T-S as master unit)	
	Fujifilm cameras(X1T-F as master unit)	
	Olympus cameras(X1T-O as master unit)	
Flash Duration t.01 (approx.)	1/220 to 1/10200 seconds	
POWER	300Ws	
Power Output	9 steps: 1/256~1/1	
Stroboscopic Flash	Provided (up to 90 times, 99Hz)	
Flash Exposure Compensation (FEC)	Adjust the parameters in the 2.4G remote control	
Sync mode	High-speed sync (up to 1/8000 seconds), first-curtain sync, and second-curtain sync	
Delay Flash	0.01~30 seconds	
Mask	√	
Beeper	√	
Modeling Lamp (LED)	12W;Color temperature: 3000-6000K±500K; Light brightness: 1 to 10 levels	
Optic Slave Flash	S1/S2	
Flash Duration Indication	√	
Wireless Flash (2.4G transmission)		
Wireless flash function	Slave, Off	
Controllable Slave groups	5 (A, B, C, D, and E)	
Transmission range (approx.)	100m	
Channels	32 (1~32)	
ID	01~99	
Power Supply		
Power Supply	Lithium battery pack (14.4V/2600mAh)	
Full Power Flashes	Approx. 320	
Recycle Time	Approx. 0.01-1.5s	
Battery Indicator	√	
Power Indication	Power standby automatically after approx. 30 minutes of idle operation.	
Sync Triggering Mode	3.5mm sync line, Wireless control port	
Color Temperature	5600±200k	
Stable Color Temperature	Change within ±100K over the entire power range in color temperature mode.	
Dimensions		
Dimension	190x100x90mm	
Net Weight	1.25kg (battery included)	

Firmware Upgrade

- USB connection line is not included in this product. The USB port is a Type-C USB socket. Type-C USB connection line is applicable.
- As the firmware upgrade needs the support of Godox G3 software, please download and install the "Godox G3 firmware upgrade software" before upgrading. Then, choose the related firmware file.
- As the product needs to do firmware upgrade, please refer to instruction manual of the newest electric version as final.

Maintenance

- Shut down the device immediately should abnormal operation be detected.
- Avoid sudden impacts and the product should be dedusted regularly.
- It is normal for the flash tube to be warm when in use. Avoid continuous flashes if unnecessary.
- Maintenance of the flash must be performed by our authorized maintenance department which can provide original accessories.
- This product, except consumables e.g. flash tube, is supported with a one-year warranty.
- Unauthorized service will void the warranty.
- If the product had failures or was wetted, do not use it until it is repaired by professionals.
- Changes made to the specifications or designs may not be reflected in this manual.

FCC

This device complies with part 15 of the FCC Rules. Operation is subject to the following two conditions: (1) This device may not cause harmful interference, and (2) this device must accept any interference received, including interference that may cause undesired operation.

Any Changes or modifications not expressly approved by the party responsible for compliance could void the user's authority to operate the equipment.

Note: This equipment has been tested and found to comply with the limits for a Class B digital device, pursuant to part 15 of the FCC Rules. These limits are designed to provide reasonable protection against harmful interference in a residential installation. This equipment generates uses and can radiate radio frequency energy and, if not installed and used in accordance with the instructions, may cause harmful interference to radio communications.

However, there is no guarantee that interference will not occur in a particular installation. If this equipment does cause harmful interference to radio or television reception, which can be determined by turning the equipment off and on, the user is encouraged to try to correct the interference by one or more of the following measures:

- Reorient or relocate the receiving antenna.
- Increase the separation between the equipment and receiver.
- Connect the equipment into an outlet on a circuit different from that to which the receiver is connected.
- Consult the dealer or an experienced radio/TV technician for help.